

Test Procedure for NCP171AMX100080TCG LDO Demoboard

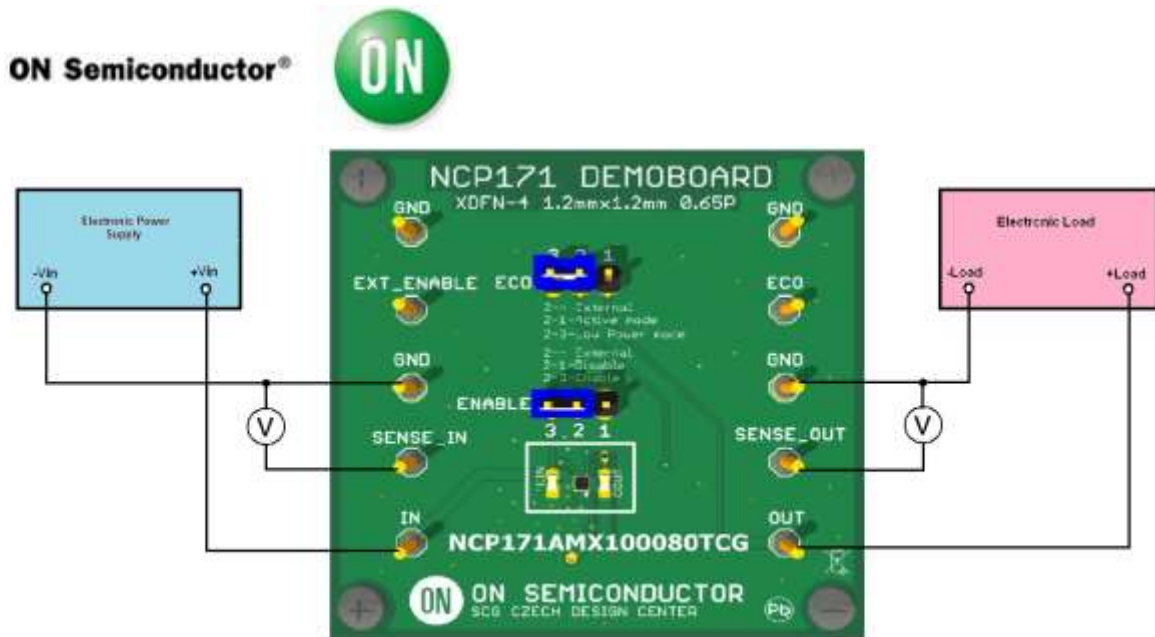

Test procedure:

1. Check the position of jumpers and correct this if necessary in accordance with the picture above.
2. Connect the test setup as shown Figure above
3. Apply an input voltage $V_{in} = 1.7 \text{ V}$
4. Apply $I_{out} = 0 \text{ mA}$ load.
5. Check that V_{out} is $0.8 \text{ V} \pm 5\%$.
6. Increase I_{out} up to 0.005 A
7. Check that V_{out} is $0.8 \text{ V} \pm 5\%$.
8. Increase V_{in} up to 5.5 V
9. Check that V_{out} is $0.8 \text{ V} \pm 5\%$.
10. Power down the Load
11. Power down the V_{cc}
12. Move the jumper ECO to position 1-2
13. Apply an input voltage $V_{in} = 1.7 \text{ V}$
14. Apply $I_{out} = 0 \text{ mA}$ load.
15. Check that V_{out} is $1.0 \text{ V} \pm 2\%$.
16. Increase I_{out} up to 0.08 A
17. Check that V_{out} is $1.0 \text{ V} \pm 2\%$.
18. Increase V_{in} up to 5.5 V
19. Check that V_{out} is $1.0 \text{ V} \pm 2\%$.
20. Power down the Load
21. Power down the V_{cc}
22. End of test